

PSoC™ Mixed-Signal Array

Preliminary Data Sheet

FAN Controller CG6457AM and CG6462AM



Features

- **Excellent for Fan Control Applications**
- **Powerful Harvard Architecture Processor**
 - M8C Processor Speeds to 12 MHz
 - Low Power at High Speed
 - 4.75V to 5.25V Operating Voltage
 - Extended Temperature Range: -40°C to +125°C
- **Advanced Peripherals (PSoC Blocks)**
 - 4 Analog Type "E" PSoC Blocks Provide:
 - 2 Comparators with DAC Refs
 - Single or Dual 8-Bit 8:1 ADC
 - 4 Digital PSoC Blocks Provide:
 - 8- to 32-Bit Timers, Counters, and PWMs
 - CRC and PRS Modules
 - Full-Duplex UART, SPI™ Master or Slave
 - Connectable to All GPIO Pins
 - Complex Peripherals by Combining Blocks
- **Flexible On-Chip Memory**
 - 4K Flash Program Storage
 - 256 Bytes SRAM Data Storage
 - In-System Serial Programming (ISSP™)
 - Partial Flash Updates
 - Flexible Protection Modes
- **Complete Development Tools**
 - Free Development Software (PSoC™ Designer)
 - Full-Featured, In-Circuit Emulator and Programmer
 - Full Speed Emulation
 - Complex Breakpoint Structure
 - 128 Bytes Trace Memory
- **Precision, Programmable Clocking**
 - Internal ±3.5% 24 MHz Oscillator
 - Internal Oscillator for Watchdog and Sleep
- **Programmable Pin Configurations**
 - 25 mA Drive on All GPIO
 - Pull Up, Pull Down, High Z, Strong, or Open Drain Drive Modes on All GPIO
 - Up to 8 Analog Inputs on GPIO
 - Configurable Interrupt on All GPIO
- **Additional System Resources**
 - I²C™ Master, Slave and Multi-Master to 400 kHz
 - Watchdog and Sleep Timers
 - User-Configurable Low Voltage Detection
 - Integrated Supervisory Circuit
 - On-Chip Precision Voltage Reference

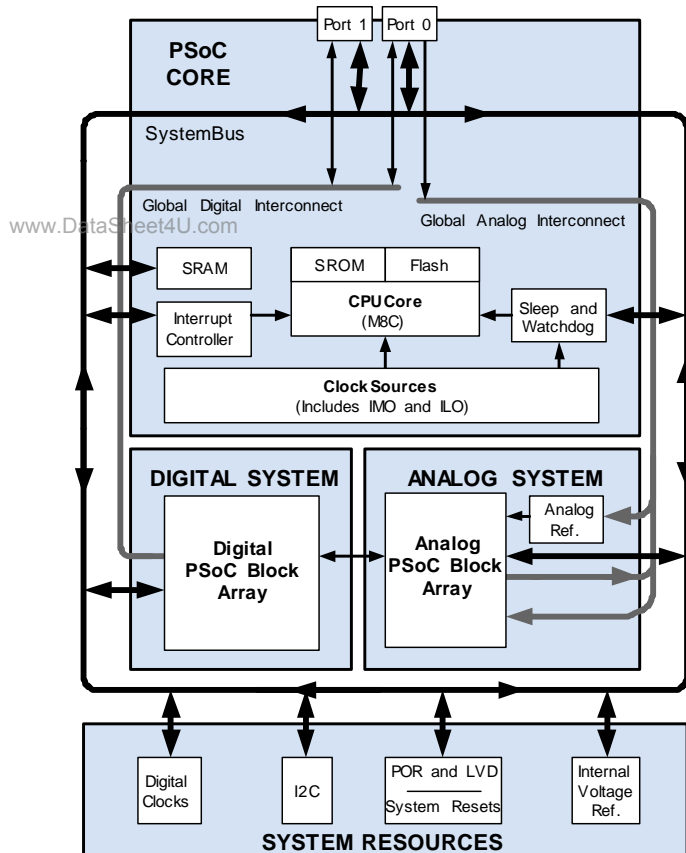

PSoC™ Functional Overview

The PSoC™ family consists of many *Mixed-Signal Array with On-Chip Controller* devices. These devices are designed to replace multiple traditional MCU-based system components with one, low cost single-chip programmable component. A PSoC device includes configurable blocks of analog and digital logic, as well as programmable interconnect. This architecture allows the user to create customized peripheral configurations, to match the requirements of each individual application. Additionally, a fast CPU, Flash program memory, SRAM data memory, and configurable IO are included in a range of convenient pinouts.

The PSoC architecture, as illustrated on the left, is comprised of four main areas: the Core, the System Resources, the Digital System, and the Analog System. Configurable global bus resources allow all the device resources to be combined into a complete custom system. Each PSoC device includes four digital blocks. Depending on the PSoC package, up to two analog comparators and up to 16 general purpose IO (GPIO) are also included. The GPIO provide access to the global digital and analog interconnects.

The PSoC Core

The PSoC Core is a powerful engine that supports a rich instruction set. It encompasses SRAM for data storage, an interrupt controller, sleep and watchdog timers, and IMO (internal main oscillator) and ILO (internal low speed oscillator). The

CPU core, called the M8C, is a powerful processor with speeds up to 12 MHz. The M8C is a two MIPS 8-bit Harvard architecture microprocessor.

System Resources provide additional capability, such as digital clocks to increase the flexibility of the PSoC mixed-signal arrays, I2C functionality for implementing an I2C master, slave, multi-master, an internal voltage reference that provides an absolute value of 1.3V to a number of PSoC subsystems, and various system resets supported by the M8C.

The Digital System is composed of an array of digital PSoC blocks, which can be configured into any number of digital peripherals. The digital blocks can be connected to the GPIO through a series of global busses that can route any signal to any pin. Freeing designs from the constraints of a fixed peripheral controller.

The Analog System is composed of four analog PSoC blocks, supporting comparators and analog-to-digital conversion up to 8 bits in precision.

The Digital System

The Digital System is composed of 4 digital PSoC blocks. Each block is an 8-bit resource that can be used alone or combined with other blocks to form 8, 16, 24, and 32-bit peripherals, which are called user module references. Digital peripheral configurations include those listed below.

- PWMs (8 to 32 bit)
- PWMs with Dead band (8 to 24 bit)
- Counters (8 to 32 bit)
- Timers (8 to 32 bit)
- UART 8 bit with selectable parity
- SPI master and slave
- I2C slave, master, multi-master (1 available as a System Resource)
- Cyclical Redundancy Checker/Generator (8 to 32 bit)
- IrDA (up to 4)
- Pseudo Random Sequence Generators (8 to 32 bit)

The digital blocks can be connected to any GPIO through a series of global busses that can route any signal to any pin. The busses also allow for signal multiplexing and for performing logic operations. This configurability frees your designs from the constraints of a fixed peripheral controller.

Digital blocks are provided in rows of four, where the number of blocks varies by PSoC device family. This allows you the optimum choice of system resources for your application. Family resources are shown in the table titled "PSoC Device Characteristics" on page 3.

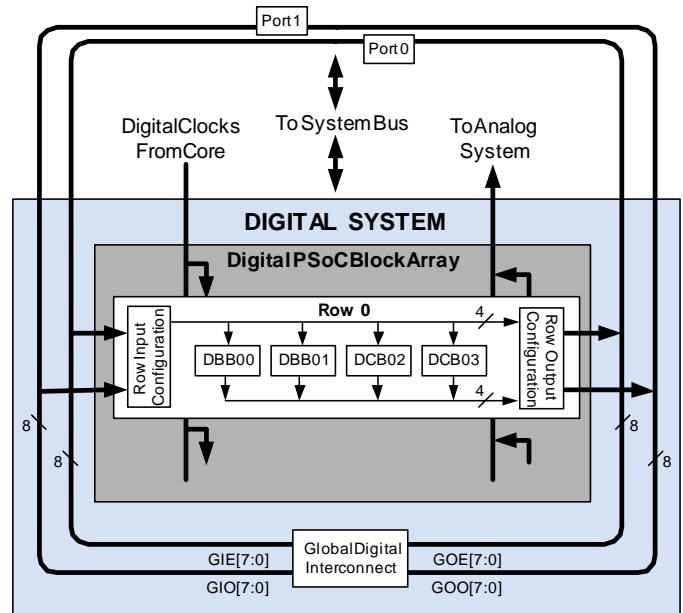

Digital System Block Diagram

The Analog System

The Analog System is composed of 4 configurable blocks to allow creation of complex analog signal flows. Analog peripherals are very flexible and can be customized to support specific application requirements. Some of the more common PSoC analog functions (most available as user modules) are listed below.

- Analog-to-digital converters (single or dual, with 10-bit resolution)
- Pin-to-pin comparators (1)
- Single-ended comparators (up to 2) with absolute (1.3V) reference
- 1.3V reference (as a System Resource)

In most PSoC devices, analog blocks are provided in columns of three, which includes one CT (Continuous Time) and two SC (Switched Capacitor) blocks. The CG64xxAM devices provide limited functionality Type "E" analog blocks. Each column contains one CT block and one SC block.

The number of blocks is on the device family which is detailed in the table titled "PSoC Device Characteristics" on page 3.

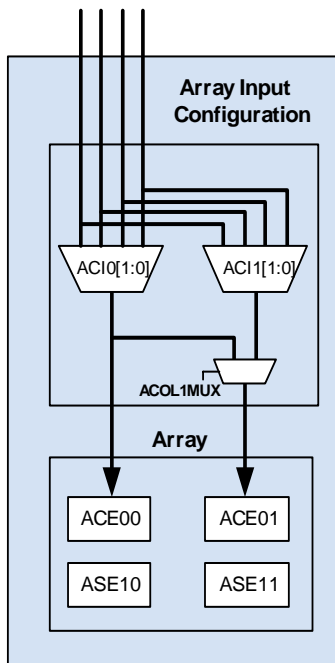

Analog System Block Diagram

Additional System Resources

System Resources, some of which have been previously listed, provide additional capability useful to complete systems. Additional resources include a switch mode pump, low voltage detection, and power on reset. Brief statements describing the merits of each system resource are presented below.

- Digital clock dividers provide three customizable clock frequencies for use in applications. The clocks can be routed to both the digital and analog systems. Additional clocks can be generated using digital PSoC blocks as clock dividers.
- The I2C module provides 100 and 400 kHz communication over two wires. Slave, master, and multi-master modes are all supported.
- Low Voltage Detection (LVD) interrupts can signal the application of falling voltage levels, while the advanced POR (Power On Reset) circuit eliminates the need for a system supervisor.
- An internal 1.3 voltage reference provides an absolute reference for the analog system, including ADCs and DACs.

PSoC Device Characteristics

Depending on your PSoC device characteristics, the digital and analog systems can have 16, 8, or 4 digital blocks and 12, 6, or 4 analog blocks. The following table lists the resources available for specific PSoC device groups. The PSoC device covered by this data sheet is highlighted below.

PSoC Device Characteristics

PSoC Device Group	Digital IO	Digital Rows	Digital Blocks	Analog Inputs	Analog Outputs	Analog Columns	Analog Blocks	Amount of SRAM	Amount of Flash
CY8C29x66	64	4	16	12	4	4	12	2K	32K
CY8C27x43	44	2	8	12	4	4	12	256 Bytes	16K
CY8C24794	56	1	4	48	2	2	6	1K	16K
CY8C24x23A	24	1	4	12	2	2	6	256 Bytes	4K
CY8C24x23	24	1	4	12	2	2	6	256 Bytes	4K
CY8C21x34	28	1	4	28	0	2	4 ^a	512 Bytes	8K
CY8C21x23	16	1	4	8	0	2	4^a	256 Bytes	4K

a. Limited analog functionality.

Example Application

To develop an application for CG6462, use the CY8C21123 in the development tools. To develop an application for CG6457, use the CY8C21323 in the development tools. Following is a high-level diagram of an ideal application using this device.

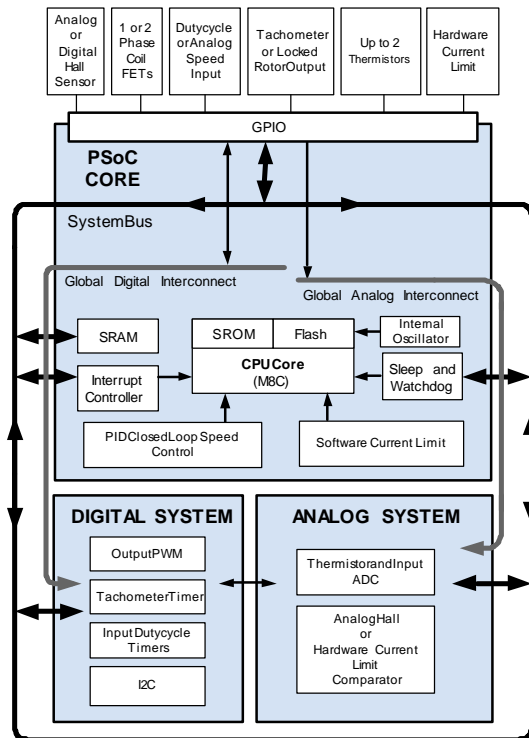

Fan Controller Block Diagram

Getting Started

The quickest path to understanding the PSoC silicon is by reading this data sheet and using the PSoC Designer Integrated Development Environment (IDE). This data sheet is an overview of the PSoC integrated circuit and presents specific pin, register, and electrical specifications. For in-depth information, along with detailed programming information, reference the *PSoC Mixed-Signal Array Technical Reference Manual*, which can be found on <http://www.cypress.com/psoc>.

For up-to-date Ordering, Packaging, and Electrical Specification information, reference the latest PSoC device data sheets on the web at <http://www.cypress.com>.

Development Kits

Development Kits are available from the following distributors: Digi-Key, Avnet, Arrow, and Future. The Cypress Online Store contains development kits, C compilers, and all accessories for PSoC development. Go to the Cypress Online Store web site at <http://www.cypress.com>, click the Online Store shopping cart icon at the bottom of the web page, and click *PSoC (Programmable System-on-Chip)* to view a current list of available items.

Technical Training

Free PSoC technical training is available for beginners and is taught by a marketing or application engineer over the phone. PSoC training classes cover designing, debugging, advanced analog, as well as application-specific classes covering topics such as PSoC and the LIN bus. Go to <http://www.cypress.com>, click on Design Support located on the left side of the web page, and select Technical Training for more details.

Consultants

Certified PSoC Consultants offer everything from technical assistance to completed PSoC designs. To contact or become a PSoC Consultant go to <http://www.cypress.com>, click on Design Support located on the left side of the web page, and select CYPros Consultants.

Technical Support

PSoC application engineers take pride in fast and accurate response. They can be reached with a 4-hour guaranteed response at <http://www.cypress.com/support/login.cfm>.

Application Notes

A long list of application notes will assist you in every aspect of your design effort. To view the PSoC application notes, go to the <http://www.cypress.com> web site and select Application Notes under the Design Resources list located in the center of the web page. Application notes are sorted by date by default.

Development Tools

PSoC Designer is a Microsoft® Windows-based, integrated development environment for the Programmable System-on-Chip (PSoC) devices. The PSoC Designer IDE and application runs on Windows NT 4.0, Windows 2000, Windows Millennium (Me), or Windows XP. (Reference the PSoC Designer Functional Flow diagram below.)

PSoC Designer helps the customer to select an operating configuration for the PSoC, write application code that uses the PSoC, and debug the application. This system provides design database management by project, an integrated debugger with In-Circuit Emulator, in-system programming support, and the CYASM macro assembler for the CPUs.

PSoC Designer also supports a high-level C language compiler developed specifically for the devices in the family.

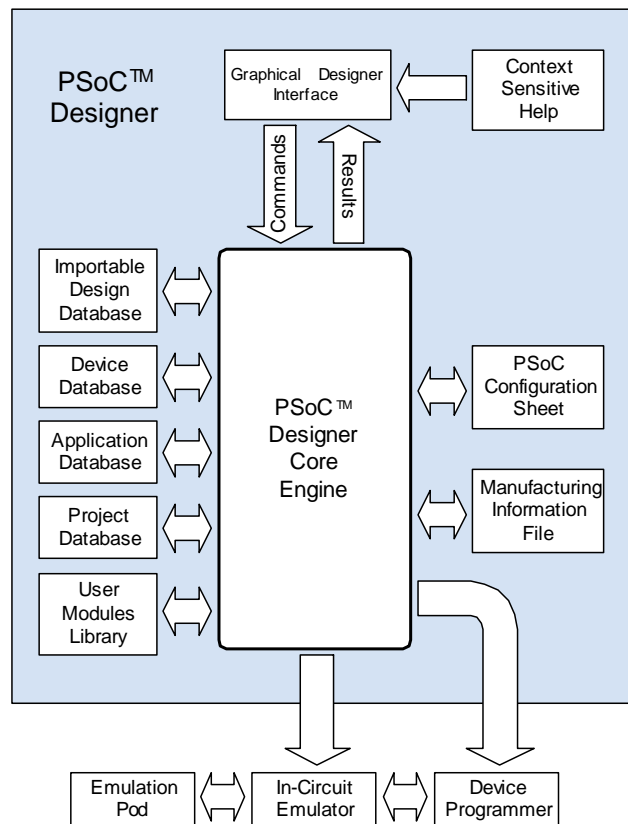

PSoC Designer Subsystems

PSoC Designer Software Subsystems

Device Editor

The device editor subsystem allows the user to select different onboard analog and digital components called user modules using the PSoC blocks. Examples of user modules are ADCs, DACs, Amplifiers, and Filters.

The device editor also supports easy development of multiple configurations and dynamic reconfiguration. Dynamic reconfiguration allows for changing configurations at run time.

PSoC Designer sets up power-on initialization tables for selected PSoC block configurations and creates source code for an application framework. The framework contains software to operate the selected components and, if the project uses more than one operating configuration, contains routines to switch between different sets of PSoC block configurations at run time. PSoC Designer can print out a configuration sheet for a given project configuration for use during application programming in conjunction with the Device Data Sheet. Once the framework is generated, the user can add application-specific code to flesh out the framework. It's also possible to change the selected components and regenerate the framework.

Design Browser

The Design Browser allows users to select and import preconfigured designs into the user's project. Users can easily browse a catalog of preconfigured designs to facilitate time-to-design. Examples provided in the tools include a 300-baud modem, LIN Bus master and slave, fan controller, and magnetic card reader.

Application Editor

In the Application Editor you can edit your C language and Assembly language source code. You can also assemble, compile, link, and build.

www.DataSheet4U.com

Assembler. The macro assembler allows the assembly code to be merged seamlessly with C code. The link libraries automatically use absolute addressing or can be compiled in relative mode, and linked with other software modules to get absolute addressing.

C Language Compiler. A C language compiler is available that supports PSoC family devices. Even if you have never worked in the C language before, the product quickly allows you to create complete C programs for the PSoC family devices.

The embedded, optimizing C compiler provides all the features of C tailored to the PSoC architecture. It comes complete with embedded libraries providing port and bus operations, standard keypad and display support, and extended math functionality.

Debugger

The PSoC Designer Debugger subsystem provides hardware in-circuit emulation, allowing the designer to test the program in a physical system while providing an internal view of the PSoC device. Debugger commands allow the designer to read the program and read and write data memory, read and write IO registers, read and write CPU registers, set and clear breakpoints, and provide program run, halt, and step control. The debugger also allows the designer to create a trace buffer of registers and memory locations of interest.

Online Help System

The online help system displays online, context-sensitive help for the user. Designed for procedural and quick reference, each functional subsystem has its own context-sensitive help. This system also provides tutorials and links to FAQs and an Online Support Forum to aid the designer in getting started.

PSoC Express Software

PSoC Express is the first visual embedded system design tool that allows a user to create an entire PSoC Project, generate a schematic, BOM, and data sheet without writing a single line of code. System designers are finally free from the low-level implementation details of "micro-coding" to work directly with application objects such as LEDs, switches, sensors, and fans. Because the details of the actual firmware are left to the PSoC Express firmware generation engine, and hidden from the user, not only are design cycles reduced from weeks and months to a few hours, but the generated, fully-tested 'C' code is completely standardized, considerably increasing overall design quality and maintainability. Go to <http://www.cypress.com/psocexpress> for free downloads and more information.

Hardware Tools

In-Circuit Emulator

A low cost, high functionality ICE (In-Circuit Emulator) is available for development support. This hardware has the capability to program single devices.

The emulator consists of a base unit that connects to the PC by way of the parallel or USB port. The base unit is universal and will operate with all PSoC devices. Emulation pods for each device family are available separately. The emulation pod takes the place of the PSoC device in the target board and performs full speed (24 MHz) operation

Designing with User Modules

The development process for the PSoC device differs from that of a traditional fixed function microprocessor. The configurable analog and digital hardware blocks give the PSoC architecture a unique flexibility that pays dividends in managing specification change during development and by lowering inventory costs. These configurable resources, called PSoC Blocks, have the ability to implement a wide variety of user-selectable functions. Each block has several registers that determine its function and connectivity to other blocks, multiplexers, busses and to the IO pins. Iterative development cycles permit you to adapt the hardware as well as the software. This substantially lowers the risk of having to select a different part to meet the final design requirements.

To speed the development process, the PSoC Designer Integrated Development Environment (IDE) provides a library of pre-built, pre-tested hardware peripheral functions, called "User Modules." User modules make selecting and implementing peripheral devices simple, and come in analog, digital, and mixed signal varieties. The standard User Module library contains over 50 common peripherals such as ADCs, DACs Timers, Counters, UARTs, and other not-so common peripherals such as DTMF Generators and Bi-Quad analog filter sections.

Each user module establishes the basic register settings that implement the selected function. It also provides parameters that allow you to tailor its precise configuration to your particular application. For example, a Pulse Width Modulator User Module configures one or more digital PSoC blocks, one for each 8 bits of resolution. The user module parameters permit you to establish the pulse width and duty cycle. User modules also provide tested software to cut your development time. The user module application programming interface (API) provides high-level functions to control and respond to hardware events at run time. The API also provides optional interrupt service routines that you can adapt as needed.

The API functions are documented in user module data sheets that are viewed directly in the PSoC Designer IDE. These data sheets explain the internal operation of the user module and provide performance specifications. Each data sheet describes the use of each user module parameter and documents the setting of each register controlled by the user module.

The development process starts when you open a new project and bring up the Device Editor, a graphical user interface (GUI) for configuring the hardware. You pick the user modules you need for your project and map them onto the PSoC blocks with point-and-click simplicity. Next, you build signal chains by interconnecting user modules to each other and the IO pins. At this stage, you also configure the clock source connections and enter parameter values directly or by selecting values from drop-down menus. When you are ready to test the hardware configuration or move on to developing code for the project, you perform the "Generate Application" step. This causes PSoC Designer to generate source code that automatically configures the device to your specification and provides the high-level user module API functions.

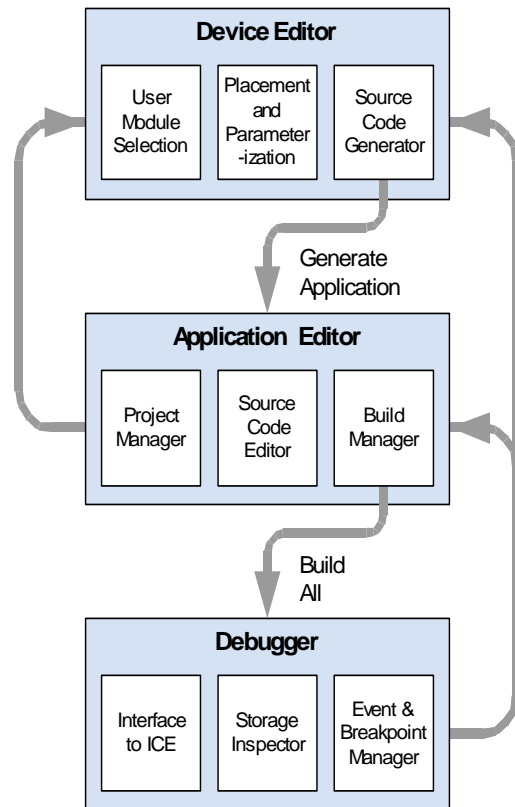

User Module and Source Code Development Flows

The next step is to write your main program, and any sub-routines using PSoC Designer's Application Editor subsystem. The Application Editor includes a Project Manager that allows you to open the project source code files (including all generated code files) from a hierarchal view. The source code editor provides syntax coloring and advanced edit features for both C and assembly language. File search capabilities include simple string searches and recursive "grep-style" patterns. A single mouse click invokes the Build Manager. It employs a professional-strength "makefile" system to automatically analyze all file dependencies and run the compiler and assembler as necessary. Project-level options control optimization strategies used by the compiler and linker. Syntax errors are displayed in a console window. Double clicking the error message takes you directly to the offending line of source code. When all is correct, the linker builds a HEX file image suitable for programming.

The last step in the development process takes place inside the PSoC Designer's Debugger subsystem. The Debugger downloads the HEX image to the In-Circuit Emulator (ICE) where it runs at full speed. Debugger capabilities rival those of systems costing many times more. In addition to traditional single-step, run-to-breakpoint and watch-variable features, the Debugger provides a large trace buffer and allows you define complex breakpoint events that include monitoring address and data bus values, memory locations and external signals.

Document Conventions

Acronyms Used

The following table lists the acronyms that are used in this document.

Acronym	Description
AC	alternating current
ADC	analog-to-digital converter
API	application programming interface
CPU	central processing unit
CT	continuous time
DAC	digital-to-analog converter
DC	direct current
FSR	full scale range
GPIO	general purpose IO
IO	input/output
IPOR	imprecise power on reset
LSb	least-significant bit
LVD	low voltage detect
MSb	most-significant bit
PC	program counter
POR	power on reset
PPOR	precision power on reset
PSoC™	Programmable System-on-Chip
PWM	pulse width modulator
ROM	read only memory
SC	switched capacitor
SRAM	static random access memory

Units of Measure

A units of measure table is located in the Electrical Specifications section. Table 3-1 on page 13 lists all the abbreviations used to measure the PSoC devices.

Numeric Naming

Hexidecimal numbers are represented with all letters in uppercase with an appended lowercase 'h' (for example, '14h' or '3Ah'). Hexidecimal numbers may also be represented by a '0x' prefix, the C coding convention. Binary numbers have an appended lowercase 'b' (e.g., 01010100b or '01000011b'). Numbers not indicated by an 'h', 'b', or 0x are decimal.

Table of Contents

For an in depth discussion and more information on your PSoC device, obtain the *PSoC Mixed-Signal Array Technical Reference Manual* on <http://www.cypress.com>. This data sheet encompasses and is organized into the following chapters and sections.

- 1. Pin Information 8**
 - 1.1 Pinouts 8
 - 1.1.1 8-Pin Part Pinout 8
 - 1.1.2 20-Pin Part Pinout 9
- 2. Register Reference 10**
 - 2.1 Register Conventions 10
 - 2.2 Register Mapping Tables 10
- 3. Electrical Specifications 13**
 - 3.1 Absolute Maximum Ratings 14
 - 3.2 Operating Temperature 14
 - 3.3 DC Electrical Characteristics 14
 - 3.3.1 DC Chip-Level Specifications 14
 - 3.3.2 DC General Purpose IO Specifications 15
 - 3.3.3 DC Amplifier Specifications 15
 - 3.3.4 DC POR and LVD Specifications 16
 - 3.3.5 DC Programming Specifications 16
 - 3.4 AC Electrical Characteristics 17
 - 3.4.1 AC Chip-Level Specifications 17
 - 3.4.2 AC General Purpose IO Specifications 18
 - 3.4.3 AC Amplifier Specifications 18
 - 3.4.4 AC Digital Block Specifications 19
 - 3.4.5 AC External Clock Specifications 20
 - 3.4.6 AC Programming Specifications 20
 - 3.4.7 AC I2C Specifications 21
- 4. Packaging Information 22**
 - 4.1 Packaging Dimensions 22
 - 4.2 Thermal Impedances 23
 - 4.3 Solder Reflow Peak Temperature 23
- 5. Ordering Information 24**
- 6. Sales and Service Information 25**
 - 6.0 Revision History 25
 - 6.1 Copyrights and Flash Code Protection 25

1. Pin Information



This chapter describes, lists, and illustrates the CG64xxAM PSoC device pins and pinout configurations.

1.1 Pinouts

The CG6462AM and CG6457AM PSoC devices are available in a variety of packages which are listed and illustrated in the following tables. Every port pin (labeled with a "P") is capable of Digital IO. However, Vss, Vdd, and XRES are not capable of Digital IO.

1.1.1 8-Pin Part Pinout

Table 1-1. 8-Pin Part Pinout (SOIC)

Pin No.	Type		Pin Name	Description
	Digital	Analog		
1	IO	I	P0[5]	Analog column mux input.
2	IO	I	P0[3]	Analog column mux input.
3	IO		P1[1]	I2C Serial Clock (SCL), ISSP-SCLK.
4	Power		Vss	Ground connection.
5	IO		P1[0]	I2C Serial Data (SDA), ISSP-SDATA.
6	IO	I	P0[2]	Analog column mux input.
7	IO	I	P0[4]	Analog column mux input.
8	Power		Vdd	Supply voltage.

CG6462AM 8-Pin PSoC Device

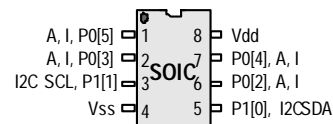

LEGEND: A = Analog, I = Input, and O = Output.

1.1.2 20-Pin Part Pinout

Table 1-2. 20-Pin Part Pinout (SSOP)

Pin No.	Type		Name	Description
	Digital	Analog		
1	IO	I	P0[7]	Analog column mux input.
2	IO	I	P0[5]	Analog column mux input.
3	IO	I	P0[3]	Analog column mux input.
4	IO	I	P0[1]	Analog column mux input.
5	Power		Vss	Ground connection.
6	IO		P1[7]	I2C Serial Clock (SCL).
7	IO		P1[5]	I2C Serial Data (SDA).
8	IO		P1[3]	
9	IO		P1[1]	I2C Serial Clock (SCL), ISSP-SCLK.
10	Power		Vss	Ground connection.
11	IO		P1[0]	I2C Serial Data (SDA), ISSP-SDATA.
12	IO		P1[2]	
13	IO		P1[4]	Optional External Clock Input (EXT-CLK).
14	IO		P1[6]	
15	Input		XRES	Active high external reset with internal pull down.
16	IO	I	P0[0]	Analog column mux input.
17	IO	I	P0[2]	Analog column mux input.
18	IO	I	P0[4]	Analog column mux input.
19	IO	I	P0[6]	Analog column mux input.
20	Power		Vdd	Supply voltage.

LEGEND A = Analog, I = Input, and O = Output.

CG6457AM 20-Pin PSoC Device

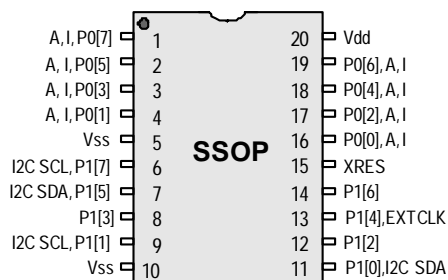

2. Register Reference



This chapter lists the registers of the CG64xxAM PSoC device. For detailed register information, reference the *PSoC™ Mixed-Signal Array Technical Reference Manual*.

2.1 Register Conventions

The register conventions specific to this section are listed in the following table.

Convention	Description
R	Read register or bit(s)
W	Write register or bit(s)
L	Logical register or bit(s)
C	Clearable register or bit(s)
#	Access is bit specific

2.2 Register Mapping Tables

The PSoC device has a total register address space of 512 bytes. The register space is referred to as IO space and is divided into two banks. The XO1 bit in the Flag register (CPU_F) determines which bank the user is currently in. When the XO1 bit is set the user is in Bank 1.

Note In the following register mapping tables, blank fields are Reserved and should not be accessed.

Register Map Bank 0 Table: User Space

Name	Addr (0,Hex)	Access	Name	Addr (0,Hex)	Access	Name	Addr (0,Hex)	Access	Name	Addr (0,Hex)	Access
PRT0DR	00	RW		40		ASE10CR0	80	RW		C0	
PRT0IE	01	RW		41			81			C1	
PRT0GS	02	RW		42			82			C2	
PRT0DM2	03	RW		43			83			C3	
PRT1DR	04	RW		44		ASE11CR0	84	RW		C4	
PRT1IE	05	RW		45			85			C5	
PRT1GS	06	RW		46			86			C6	
PRT1DM2	07	RW		47			87			C7	
	08			48			88			C8	
	09			49			89			C9	
	0A			4A			8A			CA	
	0B			4B			8B			CB	
	0C			4C			8C			CC	
	0D			4D			8D			CD	
	0E			4E			8E			CE	
	0F			4F			8F			CF	
	10			50			90			D0	
	11			51			91			D1	
	12			52			92			D2	
	13			53			93			D3	
	14			54			94			D4	
	15			55			95			D5	
	16			56			96		I2C_CFG	D6	RW
	17			57			97		I2C_SCR	D7	#
	18			58			98		I2C_DR	D8	RW
	19			59			99		I2C_MSCR	D9	#
	1A			5A			9A		INT_CLR0	DA	RW
	1B			5B			9B		INT_CLR1	DB	RW
	1C			5C			9C			DC	
	1D			5D			9D		INT_CLR3	DD	RW
	1E			5E			9E		INT_MSK3	DE	RW
	1F			5F			9F			DF	
DBB00DR0	20	#	AMX_IN	60	RW		A0		INT_MSK0	E0	RW
DBB00DR1	21	W		61			A1		INT_MSK1	E1	RW
DBB00DR2	22	RW	PWM_CR	62	RW		A2		INT_VC	E2	RC
DBB00CR0	23	#		63			A3		RES_WDT	E3	W
DBB01DR0	24	#	CMP_CR0	64	#		A4			E4	
DBB01DR1	25	W		65			A5			E5	
DBB01DR2	26	RW	CMP_CR1	66	RW		A6		DEC_CR0	E6	RW
DBB01CR0	27	#		67			A7		DEC_CR1	E7	RW
DCB02DR0	28	#	ADC0_CR	68	#		A8			E8	
DCB02DR1	29	W	ADC1_CR	69	#		A9			E9	
DCB02DR2	2A	RW		6A			AA			EA	
DCB02CR0	2B	#		6B			AB			EB	
DCB03DR0	2C	#	TMP_DR0	6C	RW		AC			EC	
DCB03DR1	2D	W	TMP_DR1	6D	RW		AD			ED	
DCB03DR2	2E	RW	TMP_DR2	6E	RW		AE			EE	
DCB03CR0	2F	#	TMP_DR3	6F	RW		AF			EF	
	30			70		RDI0RI	B0	RW		F0	
	31			71		RDI0SYN	B1	RW		F1	
	32		ACE00CR1	72	RW	RDI0IS	B2	RW		F2	
	33		ACE00CR2	73	RW	RDI0LT0	B3	RW		F3	
	34			74		RDI0LT1	B4	RW		F4	
	35			75		RDI0RO0	B5	RW		F5	
	36		ACE01CR1	76	RW	RDI0RO1	B6	RW		F6	
	37		ACE01CR2	77	RW		B7		CPU_F	F7	RL
	38			78			B8			F8	
	39			79			B9			F9	
	3A			7A			BA			FA	
	3B			7B			BB			FB	
	3C			7C			BC			FC	
	3D			7D			BD			FD	
	3E			7E			BE		CPU_SCR1	FE	#
	3F			7F			BF		CPU_SCR0	FF	#

Blank fields are Reserved and should not be accessed. # Access is bit specific.

Register Map Bank 1 Table: Configuration Space

Name	Addr (1,Hex)	Access	Name	Addr (1,Hex)	Access	Name	Addr (1,Hex)	Access	Name	Addr (1,Hex)	Access
PRT0DM0	00	RW		40		ASE10CR0	80	RW		C0	
PRT0DM1	01	RW		41			81			C1	
PRT0IC0	02	RW		42			82			C2	
PRT0IC1	03	RW		43			83			C3	
PRT1DM0	04	RW		44		ASE11CR0	84	RW		C4	
PRT1DM1	05	RW		45			85			C5	
PRT1IC0	06	RW		46			86			C6	
PRT1IC1	07	RW		47			87			C7	
	08			48			88			C8	
	09			49			89			C9	
	0A			4A			8A			CA	
	0B			4B			8B			CB	
	0C			4C			8C			CC	
	0D			4D			8D			CD	
	0E			4E			8E			CE	
	0F			4F			8F			CF	
	10			50			90		GDI_O_IN	D0	RW
	11			51			91		GDI_E_IN	D1	RW
	12			52			92		GDI_O_OU	D2	RW
	13			53			93		GDI_E_OU	D3	RW
	14			54			94			D4	
	15			55			95			D5	
	16			56			96			D6	
	17			57			97			D7	
	18			58			98			D8	
	19			59			99			D9	
	1A			5A			9A			DA	
	1B			5B			9B			DB	
	1C			5C			9C			DC	
	1D			5D			9D		OSC_GO_EN	DD	RW
	1E			5E			9E		OSC_CR4	DE	RW
	1F			5F			9F		OSC_CR3	DF	RW
DBB00FN	20	RW	CLK_CR0	60	RW		A0		OSC_CR0	E0	RW
DBB00IN	21	RW	CLK_CR1	61	RW		A1		OSC_CR1	E1	RW
DBB00OU	22	RW	ABF_CR0	62	RW		A2		OSC_CR2	E2	RW
	23		AMD_CR0	63	RW		A3		VLT_CR	E3	RW
DBB01FN	24	RW	CMP_GO_EN	64	RW		A4		VLT_CMP	E4	R
DBB01IN	25	RW		65			A5		ADC0_TR	E5	RW
DBB01OU	26	RW	AMD_CR1	66	RW		A6		ADC1_TR	E6	RW
	27		ALT_CR0	67	RW		A7			E7	
DCB02FN	28	RW		68			A8		IMO_TR	E8	W
DCB02IN	29	RW		69			A9		ILO_TR	E9	W
DCB02OU	2A	RW		6A			AA		BDG_TR	EA	RW
	2B		CLK_CR3	6B	RW		AB		ECO_TR	EB	W
DCB03FN	2C	RW	TMP_DR0	6C	RW		AC			EC	
DCB03IN	2D	RW	TMP_DR1	6D	RW		AD			ED	
DCB03OU	2E	RW	TMP_DR2	6E	RW		AE			EE	
	2F		TMP_DR3	6F	RW		AF			EF	
	30			70		RDI0RI	B0	RW		F0	
	31			71		RDI0SYN	B1	RW		F1	
	32		ACE00CR1	72	RW	RDI0IS	B2	RW		F2	
	33		ACE00CR2	73	RW	RDI0LT0	B3	RW		F3	
	34			74		RDI0LT1	B4	RW		F4	
	35			75		RDI0RO0	B5	RW		F5	
	36		ACE01CR1	76	RW	RDI0RO1	B6	RW		F6	
	37		ACE01CR2	77	RW		B7		CPU_F	F7	RL
	38			78			B8			F8	
	39			79			B9			F9	
3A				7A			BA		FLS_PR1	FA	RW
3B				7B			BB			FB	
3C				7C			BC			FC	
3D				7D			BD			FD	
3E				7E			BE		CPU_SCR1	FE	#
3F				7F			BF		CPU_SCR0	FF	#

Blank fields are Reserved and should not be accessed.

Access is bit specific.

3. Electrical Specifications



This chapter presents the DC and AC electrical specifications of the CG64xxAM PSoC device. For the most up to date electrical specifications, confirm that you have the most recent data sheet by going to the web at <http://www.cypress.com/psoc>.

Specifications are valid for $-40^{\circ}\text{C} \leq T_A \leq 85^{\circ}\text{C}$ and $T_J \leq 100^{\circ}\text{C}$, except where noted.

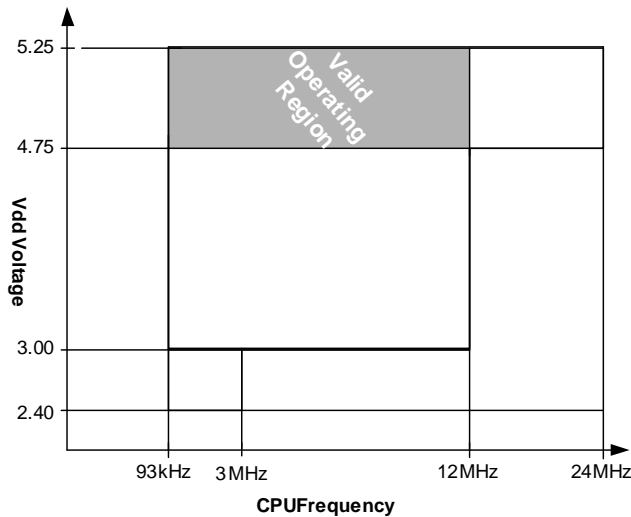

Figure 3-1. Vdd Voltage versus CPU Frequency

The following table lists the units of measure that are used in this chapter.

Table 3-1: Units of Measure

Symbol	Unit of Measure	Symbol	Unit of Measure
$^{\circ}\text{C}$	degree Celsius	μW	microwatts
dB	decibels	mA	milli-ampere
fF	femto farad	ms	milli-second
Hz	hertz	mV	milli-volts
KB	1024 bytes	nA	nanoampere
Kbit	1024 bits	ns	nanosecond
kHz	kilohertz	nV	nanovolts
k Ω	kilohm	Ω	ohm
MHz	megahertz	pA	picoampere
M Ω	megaohm	pF	picofarad
μA	microampere	pp	peak-to-peak
μF	microfarad	ppm	parts per million
μH	microhenry	ps	picosecond
μs	microsecond	sps	samples per second
μV	microvolts	σ	sigma: one standard deviation
μVrms	microvolts root-mean-square	V	volts

3.1 Absolute Maximum Ratings

Table 3-2. Absolute Maximum Ratings

Symbol	Description	Min	Typ	Max	Units	Notes
T _{STG}	Storage Temperature	-40	–	+100	°C	Higher storage temperatures will reduce data retention time.
T _A	Ambient Temperature with Power Applied	-40	–	+125	°C	
V _{DD}	Supply Voltage on V _{DD} Relative to V _{SS}	-0.5	–	+6.0	V	
V _{IO}	DC Input Voltage	V _{SS} - 0.5	–	V _{DD} + 0.5	V	
V _{IOZ}	DC Voltage Applied to Tri-state	V _{SS} - 0.5	–	V _{DD} + 0.5	V	
I _{MIO}	Maximum Current into any Port Pin	-25	–	+50	mA	
ESD	Electro Static Discharge Voltage	2000	–	–	V	Human Body Model ESD.
LU	Latch-up Current	–	–	200	mA	

3.2 Operating Temperature

Table 3-3. Operating Temperature

Symbol	Description	Min	Typ	Max	Units	Notes
T _A	Ambient Temperature	-40	–	+85	°C	
T _J	Junction Temperature at T _A ≤ 85°C	-40	–	+100	°C	The temperature rise from ambient to junction is package specific. See "Thermal Impedances" on page 23. The user must limit the power consumption to comply with this requirement.
T _{APEAK}	Peak Ambient Temperature	–	–	+125	°C	Not to exceed 5000 hours at T _A > 85°C.

3.3 DC Electrical Characteristics

3.3.1 DC Chip-Level Specifications

The following table lists guaranteed maximum and minimum specifications for the voltage and temperature ranges: 4.75V to 5.25V and -40°C ≤ T_A ≤ 85°C. Typical parameters apply to 5V at 25°C and are for design guidance only.

Table 3-4. DC Chip-Level Specifications

Symbol	Description	Min	Typ	Max	Units	Notes
V _{DD}	Supply Voltage	4.75	–	5.25	V	See DC POR and LVD specifications, Table 3-7 on page 16.
I _{DD}	Supply Current, IMO = 24 MHz	–	3	8	mA	Conditions are V _{DD} = 5.0V, CPU = 3 MHz, SYSClk doubler disabled. VC1 = 1.5 MHz, VC2 = 93.75 kHz, VC3 = 0.366 kHz.
I _{SB}	Sleep (Mode) Current with POR, LVD, Sleep Timer, WDT, and internal slow oscillator active.	–	4	8	μA	V _{DD} = 5.25V, -40°C ≤ T _A ≤ 55°C.
I _{SBH}	Sleep (Mode) Current with POR, LVD, Sleep Timer, WDT, and internal slow oscillator active.	–	5	100	μA	V _{DD} = 5.25V, 55°C ≤ T _A ≤ 125°C.
V _{REF}	Reference Voltage (Bandgap)	1.28	1.30	1.32	V	Trimmed for appropriate V _{DD} . V _{DD} = 4.75V to 5.25V.

3.3.2 DC General Purpose IO Specifications

The following table lists guaranteed maximum and minimum specifications for the voltage and temperature ranges: 4.75V to 5.25V and $-40^{\circ}\text{C} \leq T_A \leq 85^{\circ}\text{C}$. Typical parameters apply to 5V at 25°C and are for design guidance only.

Table 3-5. DC GPIO Specifications

Symbol	Description	Min	Typ	Max	Units	Notes
R _{PU}	Pull up Resistor	4	5.6	8	k Ω	
R _{PD}	Pull down Resistor	4	5.6	8	k Ω	
V _{OH}	High Output Level	V _{dd} - 1.0	–	–	V	I _{OH} = 10 mA, V _{dd} = 4.75 to 5.25V (8 total loads, 4 on even port pins (for example, P0[2], P1[4]), 4 on odd port pins (for example, P0[3], P1[5])). 80 mA maximum combined IOH budget.
V _{OL}	Low Output Level	–	–	0.75	V	I _{OL} = 25 mA, V _{dd} = 4.75 to 5.25V (8 total loads, 4 on even port pins (for example, P0[2], P1[4]), 4 on odd port pins (for example, P0[3], P1[5])). 150 mA maximum combined IOL budget.
V _{IL}	Input Low Level	–	–	0.8	V	V _{dd} = 4.75 to 5.25.
V _{IH}	Input High Level	2.1	–	–	V	V _{dd} = 4.75 to 5.25.
V _H	Input Hysteresis	–	60	–	mV	
I _{IL}	Input Leakage (Absolute Value)	–	1	–	nA	Gross tested to 1 μA .
C _{IN}	Capacitive Load on Pins as Input	–	3.5	10	pF	Package and pin dependent. Temp = 25°C .
C _{OUT}	Capacitive Load on Pins as Output	–	3.5	10	pF	Package and pin dependent. Temp = 25°C .

3.3.3 DC Amplifier Specifications

The following tables list guaranteed maximum and minimum specifications for the voltage and temperature ranges: 4.75V to 5.25V and $-40^{\circ}\text{C} \leq T_A \leq 85^{\circ}\text{C}$. Typical parameters apply to 5V at 25°C and are for design guidance only.

Table 3-6. DC Amplifier Specifications

Symbol	Description	Min	Typ	Max	Units	Notes
V _{OSOA}	Input Offset Voltage (absolute value)	–	2.5	15	mV	
TCV _{OSOA}	Average Input Offset Voltage Drift	–	10	–	$\mu\text{V}/^{\circ}\text{C}$	
I _{EBOA}	Input Leakage Current (Port 0 Analog Pins)	–	1	–	nA	Gross tested to 1 μA .
C _{INOA}	Input Capacitance (Port 0 Analog Pins)	–	4.5	9.5	pF	Package and pin dependent. Temp = 25°C .
V _{CMOA}	Common Mode Voltage Range	0.0	–	V _{dd} - 1	V	
G _{OLOA}	Open Loop Gain	80	–	–	dB	
I _{SOA}	Amplifier Supply Current	–	10	30	μA	

3.3.4 DC POR and LVD Specifications

The following table lists guaranteed maximum and minimum specifications for the voltage and temperature ranges: 4.75V to 5.25V and $-40^{\circ}\text{C} \leq T_A \leq 85^{\circ}\text{C}$. Typical parameters apply to 5V at 25°C and are for design guidance only.

Table 3-7. DC POR and LVD Specifications

Symbol	Description	Min	Typ	Max	Units	Notes
V_{PPOR2}	Vdd Value for PPOR Trip PORLEV[1:0] = 10b	–	4.55	4.70	V	Vdd must be greater than or equal to 4.75V during startup.
V_{LVD6}	Vdd Value for LVD Trip VM[2:0] = 110b	4.62	4.73	4.83	V	
V_{LVD7}	VM[2:0] = 111b	4.71	4.81	4.95	V	

3.3.5 DC Programming Specifications

The following table lists guaranteed maximum and minimum specifications for the voltage and temperature ranges: 4.75V to 5.25V and $-40^{\circ}\text{C} \leq T_A \leq 85^{\circ}\text{C}$. Typical parameters apply to 5V at 25°C and are for design guidance only.

Table 3-8. DC Programming Specifications

Symbol	Description	Min	Typ	Max	Units	Notes
$V_{dIWRITE}$	Supply Voltage for Flash Write Operations	4.25	–	–	V	
I_{DDP}	Supply Current During Programming or Verify	–	5	25	mA	
V_{ILP}	Input Low Voltage During Programming or Verify	–	–	0.8	V	
V_{IHP}	Input High Voltage During Programming or Verify	2.2	–	–	V	
I_{ILP}	Input Current when Applying V_{ilp} to P1[0] or P1[1] During Programming or Verify	–	–	0.2	mA	Driving internal pull-down resistor.
I_{IHP}	Input Current when Applying V_{ihp} to P1[0] or P1[1] During Programming or Verify	–	–	1.5	mA	Driving internal pull-down resistor.
V_{OLV}	Output Low Voltage During Programming or Verify	–	–	$V_{SS} + 0.75$	V	
V_{OHV}	Output High Voltage During Programming or Verify	$V_{DD} - 1.0$	–	V_{DD}	V	
$Flash_{DR}$	Flash Data Retention	15 ^a	100	–	Years	

a. Flash data retention is based upon a use condition of ≤ 5000 hours at $T_A \leq 125^{\circ}\text{C}$ and remaining time at $T_A \leq 60^{\circ}\text{C}$.

3.4 AC Electrical Characteristics

3.4.1 AC Chip-Level Specifications

The following table lists guaranteed maximum and minimum specifications for the voltage and temperature ranges: 4.75V to 5.25V and $-40^{\circ}\text{C} \leq T_A \leq 85^{\circ}\text{C}$. Typical parameters apply to 5V at 25°C and are for design guidance only.

Table 3-9. AC Chip-Level Specifications

Symbol	Description	Min	Typ	Max	Units	Notes
F _{IMO24}	Internal Main Oscillator Frequency for 24 MHz	23.16	24	24.84	MHz	$0^{\circ}\text{C} \leq T_A \leq 100^{\circ}\text{C}$.
F _{CPU1}	CPU Frequency (5V Nominal)	0.93	12	12.42	MHz	
F _{BLK5}	Digital PSoC Block Frequency (5V Nominal)	0	24	24.84	MHz	Refer to the AC Digital Block Specifications.
F _{32K1}	Internal Low Speed Oscillator Frequency	15	32	64	kHz	
Jitter32k	32 kHz RMS Period Jitter	–	100	200	ns	
Jitter32k	32 kHz Peak-to-Peak Period Jitter	–	1400	–	ns	
T _{XRST}	External Reset Pulse Width	10	–	–	μs	
DC24M	24 MHz Duty Cycle	40	50	60	%	
Step24M	24 MHz Trim Step Size	–	50	–	kHz	
F _{out48M}	48 MHz Output Frequency	–	–	–	MHz	Doubler. Use not allowed.
Jitter24M1	24 MHz Peak-to-Peak Period Jitter (IMO)	–	300	–	ps	
F _{MAX}	Maximum frequency of signal on row input or row output.	–	–	12.3	MHz	
T _{RAMP}	Supply Ramp Time	0	–	–	μs	

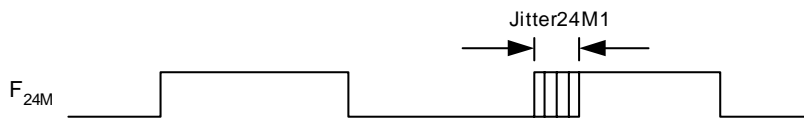

Figure 3-2. 24 MHz Period Jitter (IMO) Timing Diagram

www.DataSheet4U.com



Figure 3-3. 32 kHz Period Jitter (ILO) Timing Diagram

3.4.2 AC General Purpose IO Specifications

The following table lists guaranteed maximum and minimum specifications for the voltage and temperature ranges: 4.75V to 5.25V and $-40^{\circ}\text{C} \leq T_A \leq 85^{\circ}\text{C}$. Typical parameters apply to 5V at 25°C and are for design guidance only.

Table 3-10. AC GPIO Specifications

Symbol	Description	Min	Typ	Max	Units	Notes
F_{GPIO}	GPIO Operating Frequency	0	–	12	MHz	Normal Strong Mode
T_{RiseF}	Rise Time, Normal Strong Mode, Cloud = 50 pF	3	–	18	ns	Vdd = 4.5 to 5.25V, 10% - 90%
T_{FallF}	Fall Time, Normal Strong Mode, Cloud = 50 pF	2	–	18	ns	Vdd = 4.5 to 5.25V, 10% - 90%
T_{RiseS}	Rise Time, Slow Strong Mode, Cloud = 50 pF	10	27	–	ns	Vdd = 3 to 5.25V, 10% - 90%
T_{FallS}	Fall Time, Slow Strong Mode, Cloud = 50 pF	10	22	–	ns	Vdd = 3 to 5.25V, 10% - 90%

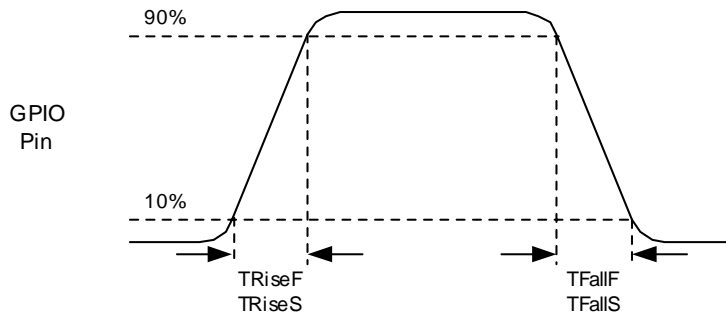

Figure 3-4. GPIO Timing Diagram

3.4.3 AC Amplifier Specifications

The following tables list guaranteed maximum and minimum specifications for the voltage and temperature ranges: 4.75V to 5.25V and $-40^{\circ}\text{C} \leq T_A \leq 85^{\circ}\text{C}$. Typical parameters apply to 5V at 25°C and are for design guidance only.

Table 3-11. AC Amplifier Specifications

Symbol	Description	Min	Typ	Max	Units	Notes
T_{COMP1}	Comparator Mode Response Time, 50 mVpp Signal Centered on Ref			200	ns	

3.4.4 AC Digital Block Specifications

The following table lists guaranteed maximum and minimum specifications for the voltage and temperature ranges: 4.75V to 5.25V and $-40^{\circ}\text{C} \leq T_A \leq 85^{\circ}\text{C}$. Typical parameters apply to 5V at 25°C and are for design guidance only.

Table 3-12. AC Digital Block Specifications

Function	Description	Min	Typ	Max	Units	Notes
All Functions	Maximum Block Clocking Frequency (> 4.75V)			24.84	MHz	4.75V < Vdd < 5.25V.
Timer	Capture Pulse Width	50 ^a	–	–	ns	
	Maximum Frequency, No Capture	–	–	24.84	MHz	4.75V < Vdd < 5.25V.
	Maximum Frequency, With or Without Capture	–	–	24.84	MHz	
Counter	Enable Pulse Width	50	–	–	ns	
	Maximum Frequency, No Enable Input	–	–	49.2	MHz	4.75V < Vdd < 5.25V.
	Maximum Frequency, Enable Input	–	–	24.6	MHz	
Dead Band	Kill Pulse Width:					
	Asynchronous Restart Mode	20	–	–	ns	
	Synchronous Restart Mode	50	–	–	ns	
	Disable Mode	50	–	–	ns	
	Maximum Frequency	–	–	24.84	MHz	4.75V < Vdd < 5.25V.
CRCPRS (PRS Mode)	Maximum Input Clock Frequency	–	–	24.84	MHz	4.75V < Vdd < 5.25V.
CRCPRS (CRC Mode)	Maximum Input Clock Frequency	–	–	24.84	MHz	
SPIM	Maximum Input Clock Frequency	–	–	8.2	MHz	Maximum data rate at 4.1 MHz due to 2 x over clocking.
SPIS	Maximum Input Clock Frequency	–	–	4.1	MHz	
	Width of SS_ Negated Between Transmissions	50	–	–	ns	
Transmitter	Maximum Input Clock Frequency	–	–	24.84	MHz	Maximum data rate at 3.08 MHz due to 8 x over clocking.
Receiver	Maximum Input Clock Frequency	–	–	24.84	MHz	Maximum data rate at 3.08 MHz due to 8 x over clocking.

a. 50 ns minimum input pulse width is based on the input synchronizers running at 12 MHz (84 ns nominal period).

3.4.5 AC External Clock Specifications

The following tables list guaranteed maximum and minimum specifications for the voltage and temperature ranges: 4.75V to 5.25V and $-40^{\circ}\text{C} \leq T_A \leq 85^{\circ}\text{C}$. Typical parameters apply to 5V at 25°C and are for design guidance only.

Table 3-13. AC External Clock Specifications

Symbol	Description	Min	Typ	Max	Units	Notes
F _{OSCEXT}	Frequency	0.093	–	24.6	MHz	
–	High Period	20.6	–	5300	ns	
–	Low Period	20.6	–	–	ns	
–	Power Up IMO to Switch	150	–	–	μs	

3.4.6 AC Programming Specifications

The following table lists guaranteed maximum and minimum specifications for the voltage and temperature ranges: 4.75V to 5.25V and $-40^{\circ}\text{C} \leq T_A \leq 85^{\circ}\text{C}$. Typical parameters apply to 5V at 25°C and are for design guidance only.

Table 3-14. AC Programming Specifications

Symbol	Description	Min	Typ	Max	Units	Notes
T _{RSCLK}	Rise Time of SCLK	1	–	20	ns	
T _{FSCLK}	Fall Time of SCLK	1	–	20	ns	
T _{SSCLK}	Data Set up Time to Falling Edge of SCLK	40	–	–	ns	
T _{HSCLK}	Data Hold Time from Falling Edge of SCLK	40	–	–	ns	
F _{SCLK}	Frequency of SCLK	0	–	8	MHz	
T _{ERASEB}	Flash Erase Time (Block)	–	15	–	ms	
T _{WRITE}	Flash Block Write Time	–	30	–	ms	
T _{DSCLK5}	Data Out Delay from Falling Edge of SCLK	–	–	50	ns	

3.4.7 AC I²C Specifications

The following table lists guaranteed maximum and minimum specifications for the voltage and temperature ranges: 4.75V to 5.25V and $-40^{\circ}\text{C} \leq T_A \leq 85^{\circ}\text{C}$. Typical parameters apply to 5V at 25°C and are for design guidance only.

Table 3-15. AC Characteristics of the I²C SDA and SCL Pins for V_{CC} ≥ 4.75V

Symbol	Description	Standard Mode		Fast Mode		Units	Notes
		Min	Max	Min	Max		
F _{SCL I2C}	SCL Clock Frequency	0	100	0	400	kHz	
T _{HDSTAI2C}	Hold Time (repeated) START Condition. After this period, the first clock pulse is generated.	4.0	–	0.6	–	μs	
T _{LOWI2C}	LOW Period of the SCL Clock	4.7	–	1.3	–	μs	
T _{HIGHI2C}	HIGH Period of the SCL Clock	4.0	–	0.6	–	μs	
T _{SUSTAI2C}	Set-up Time for a Repeated START Condition	4.7	–	0.6	–	μs	
T _{HDDATI2C}	Data Hold Time	0	–	0	–	μs	
T _{SUDATI2C}	Data Set-up Time	250	–	100 ^a	–	ns	
T _{SUSTOI2C}	Set-up Time for STOP Condition	4.0	–	0.6	–	μs	
T _{BUFI2C}	Bus Free Time Between a STOP and START Condition	4.7	–	1.3	–	μs	
T _{SPI2C}	Pulse Width of spikes are suppressed by the input filter.	–	–	0	50	ns	

a. A Fast-Mode I2C-bus device can be used in a Standard-Mode I2C-bus system, but the requirement $t_{\text{SU:DAT}} \geq 250 \text{ ns}$ must then be met. This will automatically be the case if the device does not stretch the LOW period of the SCL signal. If such device does stretch the LOW period of the SCL signal, it must output the next data bit to the SDA line $t_{\text{rmax}} + t_{\text{SU:DAT}} = 1000 + 250 = 1250 \text{ ns}$ (according to the Standard-Mode I2C-bus specification) before the SCL line is released.

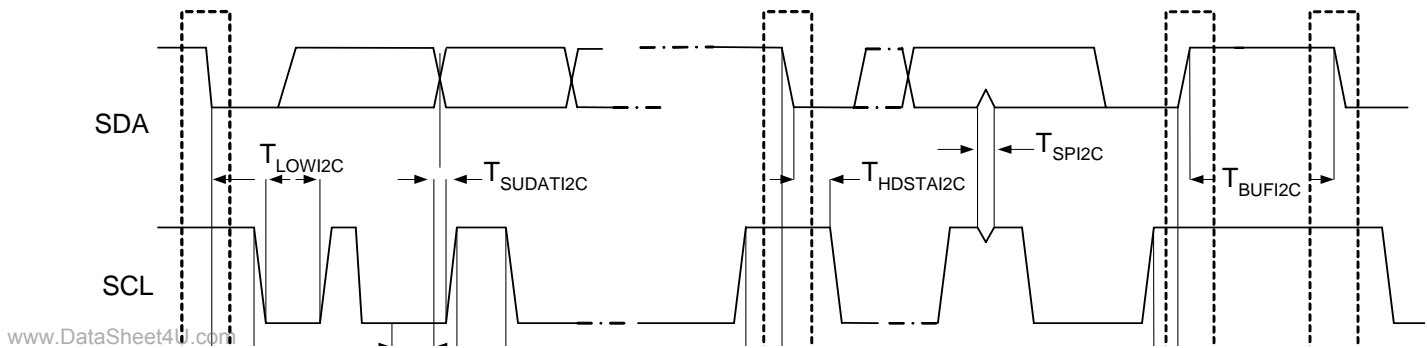

Figure 3-5. Definition for Timing for Fast/Standard Mode on the I²C Bus

4. Packaging Information



This chapter illustrates the packaging specifications for the CG64xxAM PSoC device, along with the thermal impedances for each package and minimum solder reflow peak temperature.

Important Note Emulation tools may require a larger area on the target PCB than the chip's footprint. For a detailed description of the emulation tools' dimensions, refer to the document titled *PSoC Emulator Pod Dimensions* at <http://www.cypress.com/support/link.cfm?mr=poddim>.

4.1 Packaging Dimensions

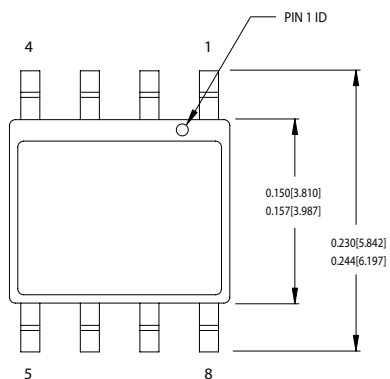

1. DIMENSIONS IN INCHES[MM] MIN. MAX.
2. PIN 1 ID IS OPTIONAL, ROUND ON SINGLE LEADFRAME RECTANGULAR ON MATRIX LEADFRAME
3. REFERENCE JEDEC MS-012
4. PACKAGE WEIGHT 0.07gms

PART #
S08.15 STANDARD PKG.
SZ08.15 LEAD FREE PKG.

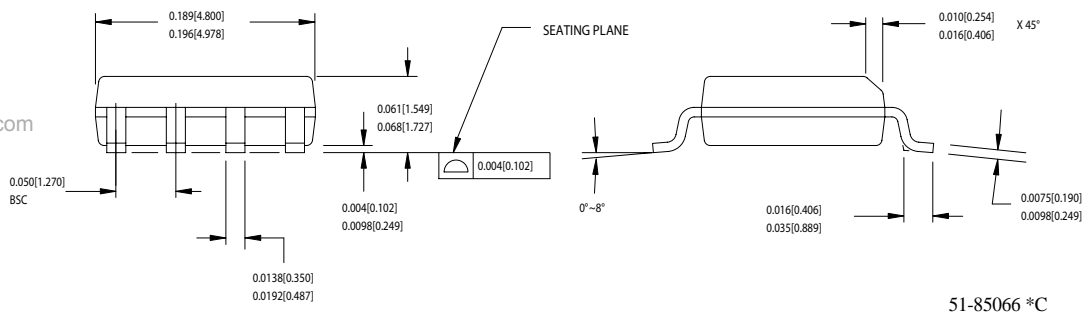

Figure 4-1. 8-Lead (150-Mil) SOIC

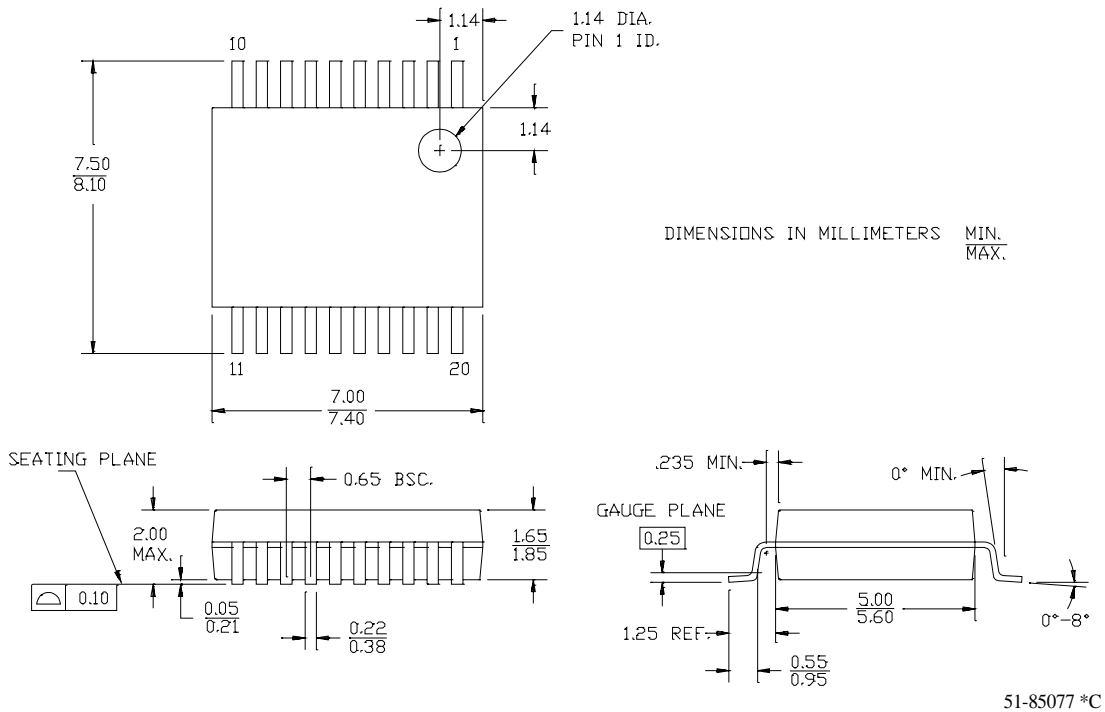

Figure 4-2. 20-Lead (210-MIL) SSOP

4.2 Thermal Impedances

Table 4-1. Thermal Impedances per Package

Package	Typical θ_{JA} *
8 SOIC	186 °C/W
20 SSOP	117 °C/W

* $T_J = T_A + \text{POWER} \times \theta_{JA}$

4.3 Solder Reflow Peak Temperature

Following is the minimum solder reflow peak temperature to achieve good solderability.

Table 4-2. Solder Reflow Peak Temperature

Package	Minimum Peak Temperature*	Maximum Peak Temperature
8 SOIC	240°C	260°C
20 SSOP	240°C	260°C

*Higher temperatures may be required based on the solder melting point. Typical temperatures for solder are 220+/-5°C with Sn-Pb or 245+/-5°C with Sn-Ag-Cu paste. Refer to the solder manufacturer specifications.

5. Ordering Information



The following table lists the CG64xxAM PSoC device's key package features and ordering codes.

Table 5-1. CG64xxAM PSoC Device Key Features and Ordering Information

Package	Ordering Code	Flash (Bytes)	RAM (Bytes)	Switch Mode Pump	Temperature Range	Digital PSoC Blocks	Analog Blocks	Digital IO Pins	Analog Inputs	Analog Outputs	XRES Pin
8 Pin (150-Mil) SOIC ^a	CG6462AM	4K	256	No	-40°C to +125°C	4	4	6	4	0	No
8 Pin (150-Mil) SOIC (Tape and Reel) ^a	CG6462AMT	4K	256	No	-40°C to +125°C	4	4	6	4	0	No
20 Pin (210-Mil) SSOP ^a	CG6457AM	4K	256	No	-40°C to +125°C	4	4	16	8	0	Yes
20 Pin (210-Mil) SSOP (Tape and Reel) ^a	CG6457AMT	4K	256	No	-40°C to +125°C	4	4	16	8	0	Yes

a. Lead-free package.

